

COMPASS PREDICTION **GRADE 6 TRIAL ONE**

2023 ACADEMIC YEAR

FOR MARKING SCHEMES:

ORDER ONLINE AT:

www.kenyaeducators.co.ke

OR

CONTACT:

Mr Machuki – 0724333200

KENYA EDUCATORS CONSULTANCY



THE COMPASS EXAMINATION BOARD

KPSEA PREDICTION

GRADE 6 - 2022

CREATIVE ARTS & SOCIAL STUDIES

Time: 1 hour 40 minutes.

INSTRUCTIONS TO CANDIDATES (Read these instructions carefully)

1. You have been given this question booklet and a separate answer sheet. The question booklet contains **80** questions divided into **four** parts: Answer **ALL** the questions in **part 1-part 3**. In **part 4**, there are two sections. Choose the section that you have been prepared for and answer all the questions.
2. Do any necessary rough work in this booklet.
3. When you have chosen your answer mark it on the **ANSWERSHEET**, not in the question paper.

HOW TO USE THE ANSWER SHEET.

4. Use an ordinary pencil only.
5. Make sure that you have written on the answer sheet:-
YOUR ASSESSMENT NUMBER
YOUR NAME
NAME OF YOUR SCHOOL
NAME OF SUBJECT
6. Do not make any marks outside the boxes.
7. Keep your answer sheet as clean as possible and **DO NOT FOLD IT**.
8. For each of the questions 1-80 four answers are given. The answers are lettered A, B, C, D. In each case only **ONE** of the four answers is correct. Choose the correct answer from the choices.
9. On the answer sheet show the correct answer by drawing a **dark line** inside the box in which the letter you have chosen is written.

Example In the Question Booklet

22. The songs sang praising one's country or leader are known as
A. sacred songs
B. patriotic songs
C. lullaby songs
D. folk songs
The correct answer is **B**

On the answer sheet:

22. [A] [B] [C] [D] 23. [A] [B] [C] [D] 24. [A] [B] [C] [D] 25. [A] [B] [C] [D]

In the set of boxes number 22, the box with letter **B** printed in it is marked.

10. Your **dark line MUST BE** within the box.
11. For each question **ONLY ONE** box is to be marked in each set of four boxes.

This question paper consists of 12 printed pages.

© compasspress, 2022

TURN OVER

PART 1: ART AND CRAFT (10mks)

1. A learner was asked to explain the meaning of tonal value. What answer did he give?
 - A. Surface feel of a drawing
 - B. The arrangement of objects in a drawing
 - C. The darkness or lightness of colour on a drawing
 - D. The size of the drawing
2. Which one of the following is **not** a factor to consider when drawing forms?
 - A. Colour of paint
 - B. Proportion
 - C. Space
 - D. Balance
3. Grade six learners drew the diagram below.



Which principle of art was lacking in the drawing?

- A. Space
 - B. Rhythm
 - C. proportion
 - D. Balance
4. Njeri was drawing overlapped forms. Which one is true about how objects should be placed?
 - A. Objects in the front to be drawn at a lower position
 - B. Objects closer to you are placed at the back
 - C. Large objects are placed in front
 - D. Objects in the front to be drawn at a higher position

5. Learners were doing painting lesson. They had paint but did not have paint brushes. Which of the following materials could they have used to improvise paint brushes?
 - A. Papers
 - B. Sisal fibre
 - C. Plastic bottles
 - D. Drinking straw
6. Grade five learners were making book covers. Which one of the following is **not** part of the book cover they made?
 - A. Spine
 - B. Front cover
 - C. Page numbers
 - D. Flaps
7. A child was seen playing with the toy drawn below

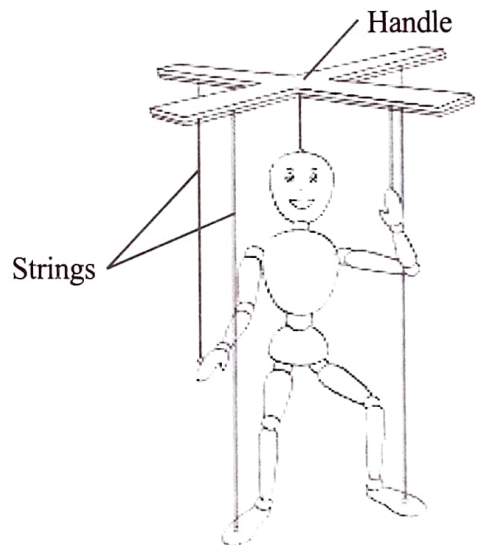

The puppet the child was playing with is called

- A. marionette
- B. glove
- C. toy
- D. rod

8. In photography, there are three view points. Which of the following is one of the view points?
- A. Eye level
 - B. Foot level
 - C. Bird's eye view
 - D. Worm's eye view

9. Study and use the colour wheel to answer the question below.

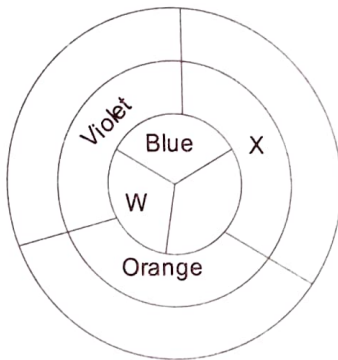

How do you get the colour labelled X? By mixing

- A. red + blue
 - B. blue + green
 - C. red + yellow
 - D. yellow + blue
10. Learners wanted to create tonal value in their paintings. Which two techniques would they use?
- A. Smudging and shading
 - B. Tinting and cross-hatching
 - C. Cross-hatching and stippling
 - D. Shading and tinting

PART 2: MUSIC (10mks)

11. The diagram below represents a wind instrument.



Which community in Kenya plays the instrument above?

- A. Luo
- B. Abaluhya
- C. Digo
- D. Abagusii

12. Grade six learners were learning about the features of folk songs. One of the features they mentioned would include whistling and ululations. This feature is called

- A. climax
- B. structure
- C. vocal ornamentation
- D. mood

13. Learners from grade five were singing the first stanza of the Kenya National Anthem in English. Which list of the words indicates where learners took a short breathe after pronouncing them?

- A. Nation, justice, may, liberty
- B. Creation, defender, dwell, peace
- C. Bless, justice, may, peace
- D. Defender, unity, creation, liberty

14. Which of the following traditional folk songs is correctly matched with the reason why it is performed?

	Type of song	Reason
A.	Worship folk songs	When mourning the dead
B.	Naming folk songs	Thanksgiving to God for new life
C.	Initiation	To motivate workers
D.	Funeral folk songs	To praise the bride and bride groom





15. A performance by two singers is called duet while a performance by three people is called
- choral
 - group
 - duet
 - trio

16. Learners were asked to match the elements of music and their meaning. Which one is correctly matched?

	Elements of Music	Description
A.	Structure	Combination of long and short sounds
B.	Tempo	Order or shape that music takes
C.	Rhythm	Speed of music
D.	Dynamics	Volume of music

17. What are the note symbols for the French rhythm below?

Taa, Ta-te, Taa-aa, Ta-te, Taa-aa-aa-aa

- A. 
- B. 
- C. 
- D. 

18. Learners were asked to identify roles played by different participants in a folk dance.

Wamalwa: Dancers play instruments

Njoroge: Soloist make dance movements

Jerono: Response group provides an answer to the soloist

Ndunge: Instrumentalist leads the rest in singing

Who among the learners gave the correct answer?

- Jerono
- Wamalwa
- Ndunge
- Njoroge

19. While singing, grade six learners were told to express the right moods as they sing. How would they NOT show the moods?

- Using facial expressions
- Laughing at each other
- Singing loudly or softly
- Singing with bright or dull voice

20. When singing the East African Community Anthem, which of the following values **cannot** be learnt from the song?

- Selfishness
- Patriotism
- Unity
- Peace

PART 3: SOCIAL STUDIES (40mks)

Study the map of Tala Area below and use it to answer questions 21-25

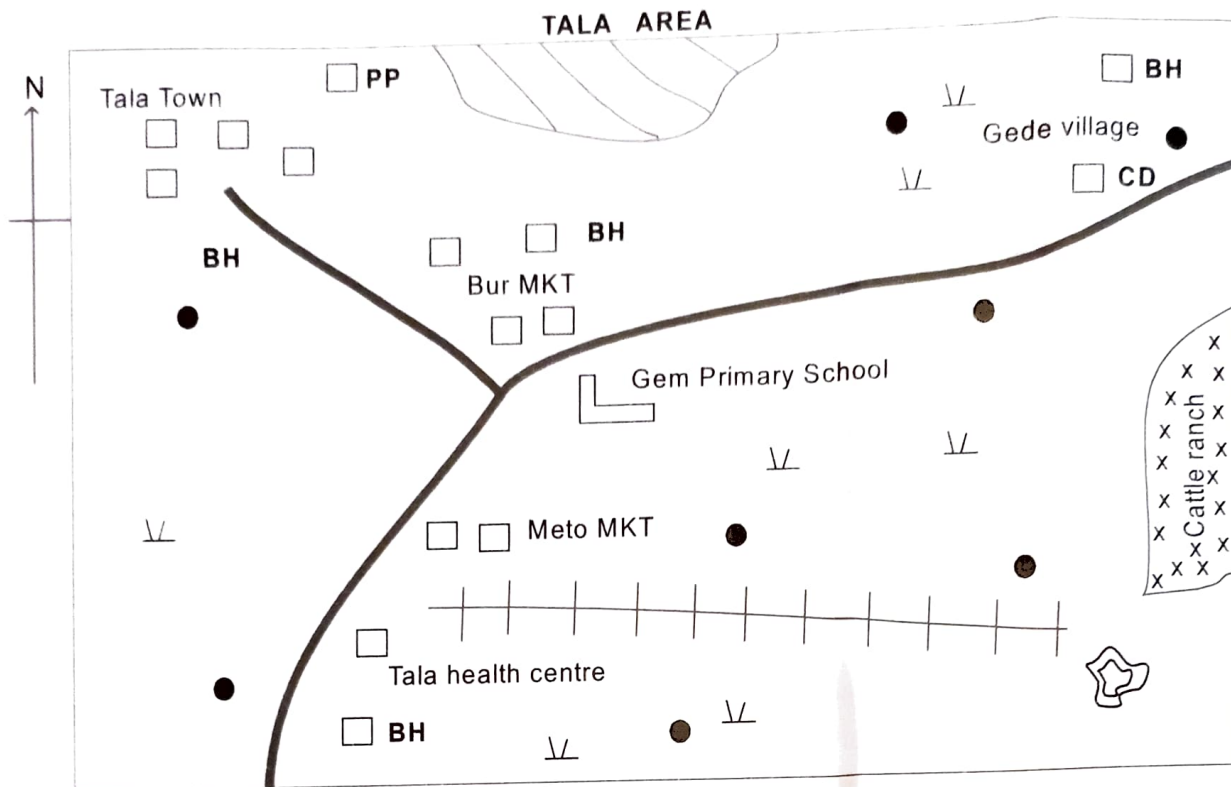

KEY 1cm rep 1km

BH	Bore hole	CD	Cattle dip		Buildings		Tarmac road
	Quarry	MKT	Market		Settlement		
	Shrubs		Game reserve		School		
PP	Police post		Railway line				

21. The direction of Tala market from Gede village is
 - A. North
 - B. South East
 - C. West
 - D. North East
22. What is likely to be transported by the railway line in the map?
 - A. Cattle
 - B. Minerals
 - C. Passengers
 - D. Wild animals
23. What is the likely climatic conditions in Tala Area?
 - A. Cool and dry
 - B. Hot and dry
 - C. Cool and wet
 - D. Hot and wet
24. Which social amenities are found in Tala Area?
 - A. School and cattle ranch
 - B. Health centre and game reserve
 - C. Game reserve and cattle ranch
 - D. Health centre and school
25. What are the economic activities that are likely to be practised in Tala Area?
 - A. Tourism and mining
 - B. Crop farming and mining
 - C. Trading and fishing
 - D. Mining and lumbering
26. Learners in grade six were identifying countries in Eastern Africa. Which country did they identify as the largest country in Eastern Africa?

A. Djibouti	B. Tanzania
C. Ethiopia	D. Sudan

27. Andrew was locating latitudes and longitudes on a map of Eastern Africa. Which of the following lines of latitude and longitude was he **unlikely** to locate on the map?

- A. 10°S and 50°E
- B. 30°N and 20°E
- C. 5°N and 35°E
- D. 15°N and 25°E

28. All the following ways of promoting unity amongst Eastern Africa Communities was mentioned by learners from a certain grade. Which one was **not**?

- A. Having common market
- B. Singing the East African Community Anthem
- C. Encouraging terrorism
- D. Through organized games and sports

29. Learners were asked by their teacher to list the mountains of Eastern Africa formed through volcanic activities.

Juma: Mt. Ruwenzori, mt. Kenya, mt. Longonot

Akothee: Mt. Elgon, mt. Meru, mt. Usambara

Omondi: Mt. Meru, mt. Kilimanjaro, mt.

Karisimbi

Kirikuu: Mt. Longonot, mt. Karisimbi, mt.

Ruwenzori

Who was correct?

- A. Juma
- B. Akothee
- C. Omondi
- D. Kirikuu

30. Learners were discussing the diagram below showing how lakes are formed.

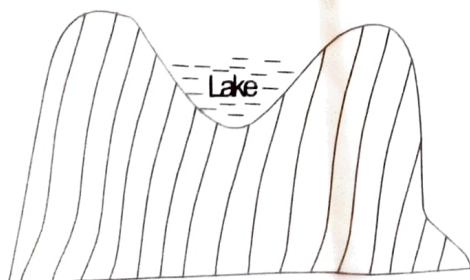

Which of the following lakes was formed as a result of the above process?

- A. Lake Victoria
- B. Lake Nakuru
- C. Lake Tanganyika
- D. Lake Paradise

31. Paul listed examples of lava dammed lakes. Which one was correct?

- A. Lake Shalla
- B. Lake Kivu
- C. Lake Magadi
- D. Lake Kyoga

32. Learners mentioned the following as characteristics of a certain climatic region in eastern Africa.

i) Experiences two rainy seasons

ii) High temperatures ranging from 21°C to 32°C

iii) Receives rainfall of not more than 1100mm per year

The climatic region described above is

- A. sub-tropical climate
- B. equatorial climate
- C. tropical climate
- D. modified equatorial

33. Musa a grade six learner matched the types of vegetation with its characteristics as shown below. Which one is correct?

	Vegetation	Characteristics
A.	Savannah grassland	Trees of medium height over large areas
B.	Mountain vegetation	Heath and moorland
C.	Desert vegetation	Evergreen
D.	Savannah woodland	Few scattered trees with tall grasses

34. Grade five learners named examples of communities that belong to the Nilotic language speakers. Which one was correct?

- A. Ameru, Pokomo, Orma
- B. Orma, Rendile, Borana
- C. Abaluhya, Abagusii, Abakuria
- D. Luo, Iteso, Turkana

35. Grade five consists of learners from different communities. How is the independence among the learners important?
 A. Promotes love and unity
 B. Promotes tribalism and racism
 C. Discourages development
 D. Promotes fighting and war
36. Learners listed the areas in Kenya with low population density. Which list is correct?
 A. Deserts, steep slopes, lake basin
 B. Deserts, near game parks, steep slopes
 C. Major towns, lake basins, highlands
 D. Highlands, desert, lake basins
37. Grade five learners were mentioning the ways through which African traditional education was practised. Which one did they **not** mention?
 A. Riddles
 B. Ceremonies
 C. Schools
 D. Songs
38. Grade five learners were discussing the values that were promoted by the African traditional education. Which one is **NOT**?
 A. Dishonesty
 B. Obedience
 C. Generosity
 D. Respect
39. When discussing the administrative leaders in the school, a learner was asked to tell the leader who is in-charge of school discipline? What did the learner say?
 A. Class teacher
 B. Head teacher
 C. Senior teacher
 D. Deputy head teacher
40. Learners were suggesting how to care for resources in Kenya. Which suggestion was wrong?
 A. Planting trees
 B. Lighting bush forests
 C. Controlling pollution of water sources
 D. Using our minerals wisely
41. Grade six learners discussed the factors suitable for dairy farming in Kenya. Which one was **not** discussed?
 A. High and reliable rainfall
 B. Cool temperatures
 C. Dry weather conditions
 D. Availability of veterinary services
42. Four learners were asked to name horticultural crops.
Amos: Grapes, orchids, kale
Daniel: Coffee, tea, mangoes
Hosea: Cabbage, roses, beans
Ezekiel: Lilies, hibiscus, lemons
 Who among them was correct?
 A. Ezekiel
 B. Daniel
 C. Hosea
 D. Amos
43. A learner matched minerals with the places they are mined. Which one was correctly matched?
- | | Mineral | Area mined |
|----|-----------|----------------|
| A. | Petroleum | Turkana county |
| B. | Salt | Kariandusi |
| C. | Flourspar | Magadi |
| D. | Limestone | Kerio Valley |
44. Which one of the following list of rivers shows where Inland fishing takes place in Kenya?
 A. Tana, Yala, Masinga
 B. Athi, Sondu Miriu, Yala
 C. Victoria, Baringo, Turkana
 D. Naivasha, Yala, Tana
45. Four learners were asked to name two of the Big-Five wild animals.
Nanyala: Giraffe, Lion
Amondi: Buffalo, hippopotamus
Aisha: Leopard, buffalo
Cherono: Elephant, giraffe
 Who among the learners was correct?
 A. Cherono
 B. Nanyala
 C. Aisha
 D. Amondi

Study the map of Kenya below and answer questions 46–49.



46. The main language group living in the area marked A is
- Cushites
 - Nilotes
 - Arabs
 - Bantus
47. What is the name of the port town marked B?
- Siaya
 - Kisumu
 - Busia
 - Kakamega
48. The river marked C drains to a swamp called
- Yalla swamp
 - Ewaso Nyiro swamp
 - Tana river swamp
 - Lorian swamp
49. The historic built environment marked D is called
- Olduvai Gorge
 - Ologasaile
 - Koobi Fora
 - Shimori Cave
50. Grade five learners were discussing about traditional leaders and their contributions in Kenya. Who among the following traditional leaders contributed to the name “Kenya” of our country?
- Nabongo Mumia
 - Chief Kivoi
 - Lenana
 - Mekatilili wa Menza
51. While talking about the early forms of government among the Maasai, a learner mentioned the name ‘Manyatta’. Manyatta is
- God
 - leader
 - warrior
 - house
52. Leonard was born outside Kenya. He is now 22 years old. How can he become a citizen of Kenya? By
- registration
 - naturalization
 - birth
 - voting
53. Learners were identifying national days celebrated in Kenya. Which of the following is NOT a National day in Kenya that is celebrated to promote unity among Kenyan?
- Good Friday
 - Madaraka day
 - Jamhuri day
 - Mashujaa day
54. A learner was highlighting how people in Kenya can participate in National governance. Which one was wrong?
- Obeying rules and laws
 - Supporting elected leaders
 - Mismanaging national resources
 - Participating in elections by voting
55. How many elected women representatives are their in the National Assembly?
- 290
 - 47
 - 16
 - 12
56. A resource person from IEBC taught grade six learners the voting steps during the voting process in Kenya. Which one was the last step?
- Get stamped ballot paper
 - Verification of voters details
 - Casting the marked ballot paper
 - Counting the votes

57. A resource person visited grade five learners and taught them about human rights. Which of the following is NOT a human right?
- Right to worship
 - Right to fair trial
 - Right to kill
 - Right to basic needs

Study the map of Eastern Africa below and answer questions 58-60

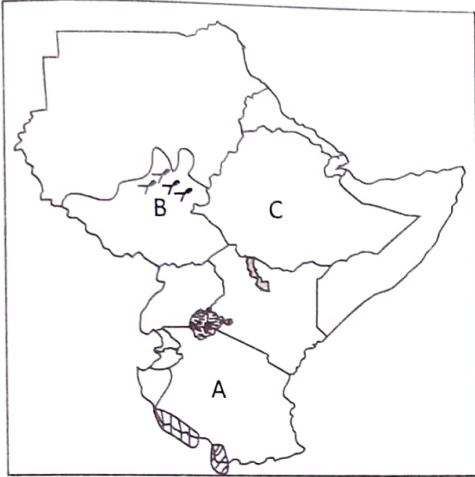

58. The capital city of the country marked A is called
- Arusha
 - Moshi
 - Dodoma
 - Dar-es-Salaam
59. The type of vegetation found in the area marked B is called
- papyrus
 - sudd
 - forests
 - reeds
60. The highest point in the country marked C is called
- mt. Birhan
 - mt. Batu
 - mt. Guna
 - Ras Dashen

PART 4:

SECTION A: CRE (20mks)

61. Nyapola is talented in sports. Which values can he use to nurture his talents?
- Hatred, respect, unity
 - Unity, responsibility, love
 - Integrity, disloyalty, disobedience
 - Love, unity, dishonesty

62. Martha's mother got married in the Africa customary marriage. How was the marriage conducted? It was conducted
- by a priest or pastor
 - in the office of the registrar
 - in the office of the chief
 - in accordance with the customs of the community

63. A young girl of 13 years in a certain part of Kajiado was married off to a rich old man. Why should such marriages be discouraged in the society? It
- violates child's rights
 - leads to development of large families
 - promotes social cohesion
 - leads to less school dropouts

64. Four learners spend their leisure time as follows:
- Ndungu: Sleeping the whole day*
Mutua: Helping the elderly
Akinyi: Visiting the sick
Kithure: Visiting orphanage
- Who among the learners did **not** use his/her leisure time properly?
- Akinyi
 - Ndungu
 - Kithure
 - Mutua

65. The following are examples of leisure activities. Which one is a passive activity?
- Swimming
 - Playing football
 - Playing video games
 - Running races

66. Grade five learners discussed with their teacher the reasons why the Bible is the inspired word of God. Which is the main reason discussed?
- It contains the word of God
 - It was written by people
 - It is sold in the bookshop
 - It is read during CRE lessons

67. Which of the lists below shows the books written by apostle Paul?
 A. Genesis, Luke, Acts, Timothy
 B. Genesis, Exodus, Deuteronomy, Leviticus
 C. Proverbs, Songs of Solomon, Luke, Acts
 D. Romans, Galatians, Philippians, Colossians
68. Mary a grade six learner was asked to identify among the ten commandments, the commandment with a promise. Which one did she identify?
 A. Do not use my name for evil purposes
 B. Respect your father and your mother
 C. Observe the Sabbath and keep it Holy
 D. Do not accuse anyone falsely
69. According to the Bible, God gave human beings the responsibility to take care of His creation. Which one is NOT away of caring for God's creation?
 A. Planting trees
 B. Polluting environment
 C. Feeding animals
 D. Cleaning the environment
70. A grade six boy dropped out of school and was employed to look after a rich man's cattle. Why should such issues be discouraged in the society? They
 A. cause good performance in schools
 B. reduce teacher's work load in schools
 C. provide source of earning to the family
 D. prevent the child from fulfilling his dream in education
71. Families can live in happiness due to the following **except**
 A. praying together
 B. spending time together
 C. leaving duties to one member of the family
 D. performing responsibilities as agreed
72. According to Acts 4:1-5, 7-13; why was Peter and John arrested?
 A. Preaching that Jesus had risen
 B. Preaching the baptism of repentance
 C. Telling lies in the synagogue
 D. Living and sharing with tax collectors
73. Who was the wisest king of Israel?
 A. David
 B. Solomon
 C. Saul
 D. Ahab
74. While king Belsharzar and his noble men were going on with their party and disrespecting the Holy vessels, a hand was seen writing on the wall. Who interpreted the writings on the wall to king Belsharzar?
 A. Elijah
 B. Angel of God
 C. Solomon
 D. Daniel
75. Elijah contested with the prophets of Baal at mt. Carmel. Elijah's prayer was heard by God because Elijah was
 A. humble
 B. obedient
 C. faithful
 D. generous
76. By taking Moses out of water and nurturing him showed that Pharaoh's daughter had the following values **except**
 A. love
 B. brutal
 C. responsibility
 D. merciful
77. According to 1 corinthians 12:1-11, which one is **NOT** a gift of the Holy spirit?
 A. Love
 B. Knowledge
 C. Healing
 D. Wisdom
78. Rachael was using social media. In order to be secure and safe she should
 A. share her personal information
 B. spend a lot of time on social media
 C. trust all the information on social media
 D. not share her personal details
79. Your father takes alot of alcohol. Why should you advice him to avoid alcohol. Because
 A. alcohol stimulates the body
 B. alcohol makes people forget things
 C. our bodies are the temple of the Holy Spirit
 D. alcohol can lead to broken families

80. According to Acts 2:42-47, believers promoted unity by
- being lazy
 - sharing meals
 - being selfish
 - gossiping

SECTION B: IRE (20mks)

61. In surah AL-Humaza Muslims are warned against three acts **except** one. Which one?
- Backbiting
 - Neglecting swalah
 - Slandering
 - Piling up of wealth
62. Which of the following statements is true about surah Al-Asr. Surah Al-Asr
- has four verses
 - encourages us to disobey our parents
 - advises Muslims not to waste time
 - was revealed in Madinah
63. Abdallah helps his uncle to sell items in his shop during Dhuhr time, he receives alot of customers. Remembering the teachings of surah Al-Takathur, what would you advice Abdallah?
- To continue selling in the shop for more profit
 - To close the shop for a while and attend the Dhuhr prayers
 - To combine swalah Dhuhr and Asr
 - To ask his uncle not to sell in the shop again
64. Surah Al-Qariah reminds Muslims to prepare for the Day of Judgement. Choose two pairs of actions that would NOT make your scale heavy on the Day of Judgement?
- Respecting your parents and meeting Qur'an
 - Seeking knowledge and giving charity
 - Reading Qur'an and reciting Adhkaar
 - Taking intoxicants and abusing others
65. Maryam emerged the best pupil in the end year assessment and was awarded sh50000 by the County Education Officer. Remembering the teachings of Surah-Al-Humaza, what would you advice Maryam to do?

- Being proud and looking down upon others
- Avoid being a miser and give of charity to the poor
- Love wealth and buy her friends good things in the market
- Backbite and insult others

66. Identify two things that Allah(SWT) is specifically NOT interested in according to the Hadith on purity of actions
- heart and deeds
 - appearance and education
 - wealth and children
 - wealth and appearance
67. The following statements describes the Islamic code of dressing. The clothes should
- not be made of gold or silk*
 - be modest*
 - be above the ankle*
 - cover the whole body except the hands and face*
 - not be transparent*
- Which of the above statements best describes a Muslim female dress?
- ii, iv, v
 - i, ii, iii
 - i, iii, iv
 - ii, iii, v
68. Rahma wrote the following statements on the importance of the Islamic manners of dressing in her notebook. Identify the statement that is NOT correct from what she wrote below. Observing the Islamic manners of dressing is important because
- it identifies one as a Muslim
 - Allah will reward us
 - it makes people know that we are wealthy
 - it makes people respect us in the society
69. According to the Hadith on planting trees and crops, a Muslim is encouraged to plant trees and crops in order to
- get wealth from it
 - conserve environment only
 - get reward of charity from Allah(SWT)
 - feed people and take care of the wild animals

70. The following are matters that we should take advantage of from the Hadith on responsible use of human capabilities and resources. Which one is **not** among them?
- Your knowledge before becoming ignorant
 - Your life before your death
 - Your wealth before you become poor
 - Your health before you become sick
71. Youthfulness is one of the bounties from Allah(SWT). Which one of the following actions would you discourage your friends to put in the energy?
- Doing a lot of work for money
 - Performing Fardh and sunnah prayers
 - Helping the elderly on household chores
 - Participating in athletics
72. Musab wrote the first four pillars of Iman on a paper. Help him arrange them in order.
- Belief in His angels
 - Belief in Allah(SWT)
 - Belief in His Books
 - Belief in His prophets
- ii, i, iii, iv
 - iii, ii, i, iv
 - iv, i, ii, iii
 - iii, iv, ii, i
73. Identify the attribute and name of Allah(SWT) in the beginning of the Islamic greetings
- Al-Ghaafah
 - Al-Salaam
 - Al-Malik
 - Al-Qayum
74. A Muslim can earn wealth through the following ways **except** one. Which one?
- Fishing
 - Carpentry
 - Teaching
 - Gambling
75. Salma wanted to know from Ahmed the Surah in the Qur'an that describes what will happen on Resurrection. Choose the correct answer given by Ahmed.
- Surah Al-Humaza
 - Surah Al-Asr
 - Surah Al-Qar'iah
 - Surah Al-Takathur
76. You were playing football with your friends. You heard Adhan from the nearby mosque. Remembering the teachings of surah Al-Asr, what would you do?
- Advise your friends to stop playing and go for Asr prayers
 - Continue playing for sometime then attend prayers later
 - Combine Asr prayers and the Maghrib prayers later
 - Advise your friends to pray the following day
77. Omar, a grade 6 learner wrote the following statements about teachings on purity of actions **except** one. Which one?
- I should have sincere intentions when performing any action
 - I should be proud of my beauty and wealth
 - I should purify my heart from all kinds of sins
 - I should perform good deeds sincerely for Allah(SWT) only
78. What is the BEST way of appreciating the bounties of Allah(SWT) in your life as a Muslim?
- Using them the way you want because it is your right
 - Using them responsibly to please Allah(SWT)
 - Using them only to benefit your family members
 - Being more active and productive when we have various bounties
79. Warda has a habit of backbiting others in class. As a Muslim, what advise would you give her to avoid this bad habit?
- Keep quiet in class during class time
 - Spending time well while performing good activities
 - Warn her and report her to the class teacher
 - Avoid talking to her in class
80. How will Allah(SWT) punish a man who wears women's clothing and the woman who wears man's clothing?
- Their prayers will not be accepted
 - They will be rewarded by Allah(SWT)
 - They will be cursed by their parents
 - They will be cursed by Allah(SWT)



THE COMPASS EXAMINATION BOARD
KPSEA PREDICTION
GRADE 6 - 2022
ENGLISH
SECTION A: LANGUAGE

Time: 1hr. 40 Mins.

INSTRUCTIONS TO CANDIDATES (Read these instructions carefully)

1. You have been given this question booklet and a separate answer sheet. The question booklet contains **40** questions.
2. Do any necessary rough work in this booklet.
3. When you have chosen your answer mark it on the **ANSWER SHEET**, not in the question paper.

HOW TO USE THE ANSWER SHEET.

4. Use an ordinary pencil only.
5. Make sure that you have written on the answer sheet:-
YOUR ASSESSMENT NUMBER
YOUR NAME
NAME OF YOUR SCHOOL
NAME OF SUBJECT
6. Do not make any marks outside the boxes.
7. Keep your answer sheet as clean as possible and **DO NOT FOLD IT**.
8. For each of the questions 1-40 four answers are given. The answers are lettered A, B, C, D. In each case only **ONE** of the four answers is correct. Choose the correct answer from the choices.
9. On the answer sheet show the correct answer by drawing a **dark line** inside the box in which the letter you have chosen is written.

**Example
In the Question Booklet**

20. Great minds think _____
A. well
B. greatly
C. might
D. a like

The correct answer is **D**
On the answer sheet:

20. [A] [B] [C] [D] 21. [A] [B] [C] [D] 22. [A] [B] [C] [D] 23. [A] [B] [C] [D]

In the set of boxes number **20**, the box with letter **D** printed in it is marked.

10. Your **dark line MUST BE** within the box.
11. For each question **ONLY ONE** box is to be marked in each set of four boxes.

This question paper consists of 8 printed pages.

© compasspress, 2022

TURN OVER
ENGLISH GRADE 6

Study the picture below and answer questions 1-8



Every meal can serve as an opportunity for you to learn how to exercise proper table etiquette. From using your utensils properly to waiting until everyone has been served, you can learn how to be respectful and practise table manners. First and foremost, come to the table with hands and face clean. Washing up before dinner not only shows respect for the person who prepared the meal as well as others at the dinner table, but it is also an important healthy hygiene habit.

In addition, always wait until everyone has served before starting to eat. Starting to eat before everyone has been seated is disrespectful. Meals are meant to be enjoyed together. It is also wise to chew with your mouth closed and do not talk before swallowing food. It is disgust to show other people. Avoid stuffing your mouth with food. Take small bites and never wolf down their food. It is uncultured to eat as though you were in a competition. Eat at a moderate pace. Be polite during meals. If you ask for someone to pass something to you, remember to use should 'please'. It is also wrong to reach across the table for anything you need. Feel free to seek the assistance of any person closer to it. Do not forget to say thank once you have been assisted. It is equally noble to show gratitude to the person who prepared the meal or anyone serving you. Do not criticize food even if it is not your favourite or if it has not been prepared to your standards.

Whenever possible, seek to know if you can be of any help during meal time. You can help in arranging the cutlery or even getting the dessert to the table. It is worth noting that meal time is not just about eating. It is also an opportunity to connect with those you are dining. Some conversations to share an experience will go a long way in helping you bond with other dinners. Consequently, do not bring along electronics. It is disrespectful to bring electronics to the table. Using them is even worse. During table conversations, wait for your turn to speak. Do not interrupt any person speaking. Ask to be excused if you have to leave the table for any valid reason. Take your plates and cutlery away from the table. Clear the leftovers into the trash. Place the plates and other in the sink or whatever place you have designated.

1. **Table etiquette** means
 - A. serving little food at a time.
 - B. sharing table with other people during meals.
 - C. practising good manners during meals.
 - D. having good conversations during meals.
2. Why is it important to go to table with clean hands and face?
 - A. To avoid wastage of time.
 - B. To show respect for other people we interact with.
 - C. It is hygienic to do so.
 - D. To ensure the cutlery is kept clean
3. What should you do when you are at the table?
 - A. Only start eating when everyone has served.
 - B. Start eating as soon as you have served.
 - C. Pray when others are served.
 - D. Start eating when everyone else has eaten.
4. It is wrong to chew food with the mouth open because
 - A. you may get choked.
 - B. you may take too long to finish food.
 - C. you cannot swallow the food well.
 - D. you may show the food you are chewing to other people.
5. What should you say when you have got assistance from the other people at the table?
 - A. It is okey.
 - B. Thank you.
 - C. Excuse me.
 - D. You are most welcome.
6. What should you do if you realise the food you have served is **not** as delicious as you would have liked it?
 - A. Tell the other people at the table.
 - B. Do not continue eating.
 - C. Do not say anything negative to the people at the table.
 - D. Tell the person who prepared the food to use more spices next time.
7. According to the story it is true to say that, conversations at the table
 - A. should be avoided.
 - B. are quite healthy.
 - C. need to be about food only.
 - D. should be done immediately after the meal.
8. Which one of the following is **not** an example of cutlery?
 - A. fork
 - B. knife
 - C. spoon
 - D. cup

Read the passage below and answer questions 9 to 16.

Once upon a time there lived a lion in a forest. He preferred to live alone as he did not like being bothered by anyone. Being strong and swift, he easily caught his preys. He always had plenty to eat. It was no wonder therefore that he was very healthy.

One afternoon, the lion was resting in the shade after a heavy meal. He easily fell asleep. Suddenly, his sleep was interrupted by some movement across his body. On opening his eyes, he was astonished at what he saw. A tiny mouse was playing with on the lion's body. Filled with rage, the lion grabbed the mouse with his paw. He was about to squeeze the tiny creature to death when the mouse pleaded for mercy. He promised that one day, he would come to the lion's aid. Feeling amused, the lion wondered how such a helpless small animal could be of his help. Anyway, he let go of him due to pity.

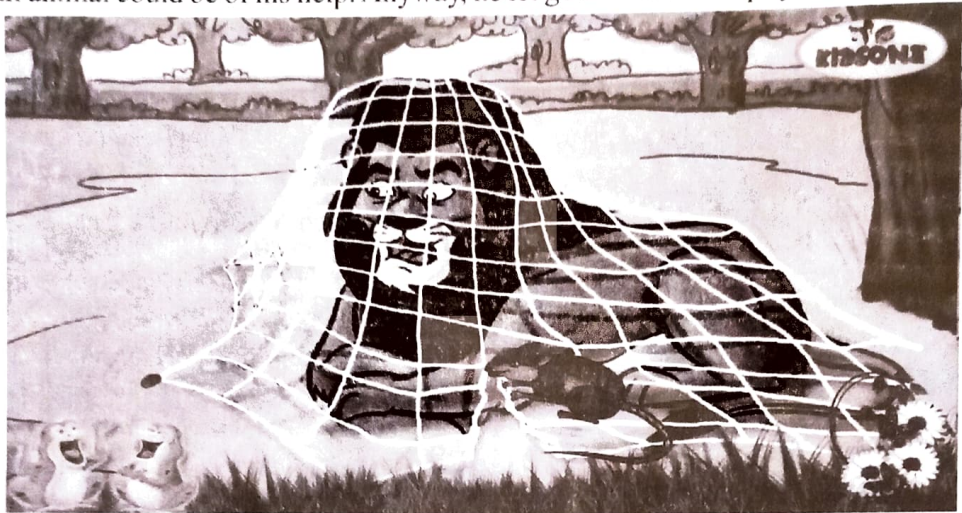

On another day, the lion was wandering in the forest looking for a prey. Unfortunately, he got caught in a trap set by a hunter. The trap was made up of a net. He tried to free himself but his effort bore no fruit. Knowing what would happen to him if the hunter found him there, he started roaring as loud as he could hoping that another animal would come to his rescue. Luckily, the mouse happened to have been within the vicinity. He came towards the trap and cut the net with its teeth. It did not take long before he freed the lion. Once free, the lion thanked the mouse. He regretted that he had previously considered the mouse to be too small to offer him any assistance.

9. The lion lived alone because he
 - A. did not like to be disturbed.
 - B. was the king.
 - C. was selfish.
 - D. got angry very fast.

10. Why was it very easy for the lion to get food?
 - A. He was cunning.
 - B. He was fast and had great strength.
 - C. Other animals were scared of him.
 - D. There were many small animals in the forest.

11. What happened when the lion was resting in the shade?
 - A. He got attacked.
 - B. He became angry.
 - C. He felt insecure.
 - D. He found himself in slumberland.

12. The word **astonished** as used in the story means the same as
- A. surprised
 - B. confused
 - C. angry
 - D. challenged
13. Why was the lion very angry?
- A. He had seen a tiny mouse.
 - B. He could not sleep at all.
 - C. A small animal was playing on its body.
 - D. He heard some movements.
14. Why did the lion **not** kill the mouse?
- A. The mouse promised to help him.
 - B. He had sympathy for the mouse.
 - C. The mouse escaped narrowly.
 - D. The mouse had made him laugh.
15. The phrase **his effort bore no fruit** means that the lion
- A. was desperate.
 - B. got too tired to do anything.
 - C. was in urgent need of help.
 - D. was unable to free himself.
16. Which proverb best summarises the last sentence of the passage?
- A. All that glitters is not gold.
 - B. Unity is strength.
 - C. Do not judge a book by its cover.
 - D. Patience pays.

Read the passage below and answer questions 17 to 24.

It was the first day of my August holiday and I was very excited to have a lot of days to have fun. I hoped to play with my friends and read as many storybooks as possible. However, it came to my realisation that most of my friends had travelled to other parts of the country to visit their relatives. To make matters worse, the library in the neighbourhood had closed for renovation. Consequently, I could not read any storybooks. I felt saddened by the turn of events. It was as clear as crystal that I would have the worst holiday ever.

It did not take long before my mother noticed my long face. She sought to know why I appeared gloomy. When I explained to her my concerns, she cheered me up saying, “Your holiday has not been ruined, son. There are different other things you can do this holiday not only to make yourself happy but also to put a smile on other people’s faces. She explained to me how I could visit other children who are less privileged and provide them with food, clothes and even help them to know how to read and write. I listened with great interest as my mother described essential things that many other children are deprived of. As mother finished, my eyes sparkled as I had realised that school holidays are not only meant for fun and personal study. We can do many a few things here and there to better other people’s lives.



The next morning, I got up early and went to the shopping mall with my mother. We bought some clothes and foodstuff. Then she took me to an underprivileged area of the city where we distributed the clothes and food among several children. My mother and I also spent some time showing the children how to read and write. Sadly, most of the children had never been to school. They were eager to learn how to write and read some simple words. When the day ended, we were fatigued but very happy at our accomplishment. From that day on, a new journey began that changed my life. I would distribute food and clothes in different poor to street families in the morning, did my school homework in the noon and taught some children in the evening. When the holiday ended, I was feeling happy and satisfied as this was my most fulfilling vacation.

17. Why was the writer excited?
 A. Schools were closed.
 B. He looked forward to enjoying his holiday.
 C. He was planning to visit his friends.
 D. He had planned to travel.
18. Why were the writer's friends unavailable?
 A. They were enjoying themselves at home.
 B. They were engaged in different activities.
 C. The writer had no idea what had happened to them.
 D. They were spending the holiday with their relatives.
19. The writer could not go to the library because
 A. he was very busy.
 B. it was out of use.
 C. it did not have many books.
 D. it was far away.
20. Why was the writer unhappy?
 A. He had a long face.
 B. He missed school.
 C. He thought his holiday would be boring.
 D. His friends had let him down.
21. The holiday plan that the writer's month came up with
 A. was exciting to the writer.
 B. was meant to benefit the writer alone.
 C. would give the writer a chance to travel to many towns.
 D. did not help the writer much.

22. Which kinds of children did the writer plan to help?
 A. His friends.
 B. His schoolmates.
 C. Children from very poor families.
 D. Children who had invited him.
23. Why did the writer and his mother go to the shopping mall?
 A. To have fun.
 B. To purchase food and clothing.
 C. To get items they could use at home.
 D. To carry out window shopping.
24. The holiday the writer had can be described as
 A. boring
 B. short
 C. fruitful
 D. saddening

Fill in the blank spaces numbered 25 to 30 with the best alternative from the choices given

Last week, there was a very serious accident involving two passenger buses. The accident _____ **25** _____ when one bus that was heading to Furaha town tried to overtake a trailer around a bend. Unfortunately, there was another bus coming from the opposite direction. _____ **26** _____ both buses were speeding, the drivers tried to apply the brakes but it was too late. The two buses _____ **27** _____ head-on. They rolled out of the road due to impact and landed in a ditch. Many people were seriously injured. Luckily, no one died. Some pedestrians rushed to the _____ **28** _____ to offer first aid to the victims of the accident. They called the paramedics _____ **29** _____ arrived in several ambulances and rushed the victims of the accident to hospital for _____ **30** _____.

- | | | | | |
|-----|---------------|-------------|-------------|-------------|
| 25. | A. occurred | B. ocured | C. ocurred | D. started |
| 26. | A. But | B. And | C. Since | D. Although |
| 27. | A. met | B. colluded | C. hit | D. collided |
| 28. | A. place | B. seen | C. scene | D. sight |
| 29. | A. whom | B. who | C. whose | D. which |
| 30. | A. medication | B. caring | C. medicine | D. health |

For questions 31 to 33, choose the best alternative to complete sentences.

31. It took the fire fighters a long time to _____ the fire.
 A. put off
 B. call off
 C. put out
 D. put away
32. Mercy ran as fast as she could _____ did not win the race.
 A. and
 B. but
 C. therefore
 D. since

33. Trevor is the _____ of the twins.
A. most clever
B. more clever
C. cleverest
D. cleverer

Choose the alternative that is similar in meaning to the underlined word.

34. The lady **seldom** visits her farm.
A. often
B. never
C. hardly
D. usually
35. A **fatal** disease has broken out in the area.
A. dangerous
B. deadly
C. serious
D. strange

Complete the sentences correctly.

36. We do not have _____ homework this weekend.
A. some
B. much
C. many
D. most
37. This is the boy _____ the head teacher rewarded.
A. whom
B. whose
C. who
D. which
38. My uncle bought me a _____ ball.
A. new, small, green
B. small, green, new
C. new, green, small
D. small, new, green

In questions 39 and 40, choose the sentence that is correctly punctuated.

39. A. He said, "My son goes to Mawingu secondary school."
B. "What a cold day it is?" the old man exclaimed.
C. George asked, "What are you doing, Kenneth?"
D. "We often swim at the weekend," Said the children.
40. A. The mans' shoes are new.
B. The shop sells ladies clothes.
C. Men's suits cost a lot of money.
D. Childrens' toys are available in this shop.



THE COMPASS EXAMINATION BOARD
KPSEA PREDICTION

GRADE 6 - 2022

INTEGRATED SCIENCE

Time: 1hr. 30 Mins.

INSTRUCTIONS TO CANDIDATES (Read these instructions carefully)

1. You have been given this question booklet and a separate answer sheet. The question booklet contains **60** questions. Answer **ALL** the questions in each section.
2. Do any necessary rough work in this booklet.
3. When you have chosen your answer mark it on the **ANSWER SHEET**, not in the question paper.

HOW TO USE THE ANSWER SHEET.

4. Use an ordinary pencil only.
5. Make sure that you have written on the answer sheet:-
YOUR ASSESSMENT NUMBER
YOUR NAME
NAME OF YOUR SCHOOL
NAME OF SUBJECT
6. Do not make any marks outside the boxes.
7. Keep your answer sheet as clean as possible and **DO NOT FOLD IT**.
8. For each of the questions 1-60 four answers are given. The answers are lettered A, B, C, D. In each case only **ONE** of the four answers is correct. Choose the correct answer from the choices.
9. On the answer sheet show the correct answer by drawing a **dark line** inside the box in which the letter you have chosen is written.

**Example
In the Question Booklet**

49. The ability of soil to allow water to pass through its particles is called
- A drainage
 - B texture
 - C capillarity
 - D water retention

The correct answer is A

On the answer sheet:

47. [A] [B] [C] [D] 48. [A] [B] [C] [D] 49. [A] [B] [C] [D] 50. [A] [B] [C] [D]

In the set of boxes number 49, the box with letter A printed in it is marked

10. Your **dark line MUST BE** within the box.
11. For each question **ONLY ONE** box is to be marked in each set of four boxes.

This question paper consists of 12 printed pages.

© compasspress, 2022

TURN OVER

SECTION A:

SCIENCE & TECHNOLOGY (25mks)

1. During a nature walk, a grade six learner observed a plant with the following characteristics:-

-Small in size

- Has soft green stem

Which plant was observed?

- A. Mint
 - B. Orange
 - C. Rose plant
 - D. Nappier grass
2. Grade six learners set -up the experiment below to investigate functions of a certain part of a plant.

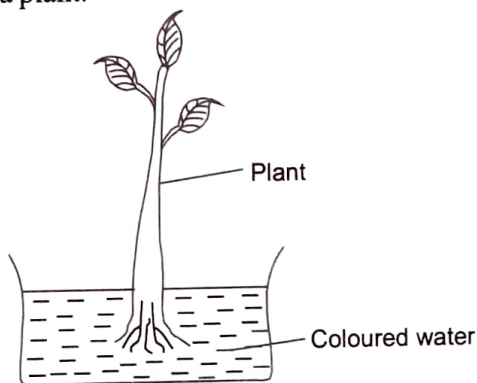

After sometimes the learners cut the stem of the plant and noticed a colour in it. What conclusion did they make?

- A. Leaves manufacture food for plants
- B. Stems absorb water
- C. Roots absorb water
- D. Coloured water travels in plant

3. Which of the following is both the function of roots and stems?

- A. Exchange of gases
- B. Food storage
- C. Absorption of water
- D. Anchorage of the plants

4. Tonet was asked to name at least three plants that have fibrous roots. Which of the following lists shows the plants mentioned?

- A. Maize, sorghum, beans, millet
- B. Sorghum, rice, wheat, maize
- C. Grass, peas, beans, carrot
- D. Carrots, beans, groundnuts, peas

5. During a nature walk, grade six learners collected samples of animals without backbone. Which animals did they collect?

- A. Lizard, ladybird, locust, tick
- B. Ladybird, cockroach, bat, lice
- C. Locust, cricket, cockroach, gecko
- D. Ladybird, cricket, locust, lice

6. Grade six learners were advised not to make noise when approaching invertebrates animals. Why do you think so?
- Noise scares animals away
 - Noise makes animals come near
 - Noise makes animals dormant
 - Noise soothes invertebrates
7. During break time, Anderi saw a butterfly in the school field. Which one is **false** about the insect?
- Has three body parts
 - Has feelers
 - Has eight legs
 - Has six legs
8. Learners from grade five were asked by their Science and Technology teacher to observe the sky just after sunset and name the phase of the moon seen to the west. What answer did they give?
- Crescent
 - Full moon
 - New moon
 - Gibbous
9. A girl was walking home to school. How does the sun's heat reach the girl? Through
- convection
 - radiation
 - conduction
 - evaporation
10. Otieno's father is working in a factory that produces a lot of noise. How would Otieno's father protect himself from the loud sound in the factory?
- By leaving the job
 - By going near where loud sound is produced
 - Protesting to the factory to stop the noise
 - Wearing protective gears while at work

Use the diagram below to answer questions 11- 12

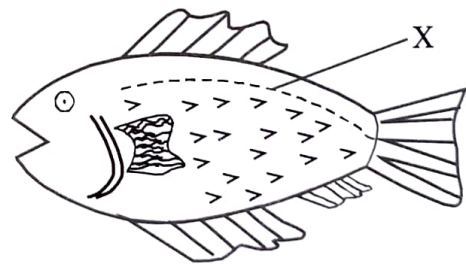

11. How does the animal in the diagram above reproduce? By
- giving birth to young ones
 - laying eggs
 - not reproducing
 - vomiting eggs

12. The part marked X is very important to the animal. It is used for
- breathing
 - reproduction
 - sensing
 - swimming
15. There are plastic waste bottles littered all over Debe Primary School. In what two ways would grade six learners manage the waste bottles?
- Reusing and reducing
 - Reducing and recycling
 - Recycling and reusing
 - Burning and reusing

The chart below shows the changes of state of matter. Use it to answer questions 13 and 14

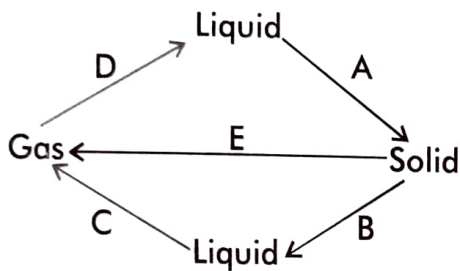

13. Which of the processes require increase in temperature?
- A and B
 - C and D
 - B and D
 - B and C
14. The process marked E is called
- sublimation
 - evaporation
 - condensation
 - freezing
16. A notice was displayed at the hospital gate with the following information
- VISIT THE DOCTOR IF YOU OBSERVE
AND EXPERIENCE THE FOLLOWING:**

 - Anaemia
 - Skin rash that is red and itchy
 - Tiredness and weakness
 - Stomach pain and diarrhoea
 - Loss of appetite
 - Malnutrition
- Which internal parasite were people being warned against?
- Tapeworm
 - Hookworm
 - Roundworm
 - Pinworm

17. People working in rice paddy fields are likely to suffer from
- A. bilharzia
 - B. dysentery
 - C. cholera
 - D. typhoid

18. Leina was eating fish and ugali during lunch time. Where in the human digestive system would the food be absorbed?
- A. Stomach
 - B. Mouth
 - C. Large intestine
 - D. Small intestine

19. A grade five learner observed the tooth below.



How can the tooth problem observed above be prevented? By

- A. eating biscuits
- B. brushing the teeth regularly
- C. eating sugary foods
- D. opening soda bottle tops with the teeth.

20. Which of the following is the importance of mushroom? It is
- A. a source of medicine
 - B. used for baking bread
 - C. a source of food
 - D. used for processing beverages

TECHNOLOGY

21. Mucheru was writing a word document on a computer device. He realizes he has made a mistake. Which two keys can he use to correct the mistake and insert the right words?
- A. Capslock key and delete key
 - B. Delete key and backspace key
 - C. Backspace key and F1 key
 - D. Control key and delete key

22. Grade five computer teacher advised the learners to observe safety when using computer devices. Which one of the following is a safety measure the class should observe?
- A. Take responsibility for your actions
 - B. Waste time as you work on your document
 - C. Never follow the instructions
 - D. Leave the computer on with the document you typed displayed.

23. Games, animations and songs created through computer applications such as scratch are used for

- A. typing documents
- B. editing documents
- C. saving documents
- D. entertainments purposes

24. Which of the following parts of a computer devices is correctly matched with its function?

Part	Function
A. Monitor	Types in a computer
B. Mouse	Moves on flat surface and gives instructions
C. Keyboard	Displays the information
D. Processor	Connect devices to its hardware

25. Find the value of letter P in the puzzle below

1		4
P	2	8
	5	

- A. 12
- B. 3
- C. 6
- D. 7

SECTION B:

HOME SCIENCE (10mks)

26. During guidance and counselling session, Mr. Kendi talked about the changes that occur during adolescence in both boys and girls. Which of the physical changes below takes places in boys only?

- A. Development of breasts
- B. Growth of hair under the armpits and pubic area
- C. Development of pimples over the face
- D. Experiencing wet dreams

27. Wambui, a grade six learner listed good grooming habits for adolescent girls only. Which one is **true**?

- A. Combing their hair
- B. Changing their sanitary towels regularly
- C. Wearing clean and decent clothes
- D. Bathing daily to prevent bad odour

28. Which safety precaution should not be observed by adolescents when interacting and socializing?

- A. Giving your personal information to strangers you meet on social media
- B. Avoiding walking in dark and deserted places
- C. Avoiding gifts from strangers
- D. Avoiding bad company

29. Anita's mother bought her the following cosmetics for her good grooming: eye pencil, lipsticks and body lotions. Anita on the other hand would be seen applying excess lipsticks on her lips. What danger is Anita exposed to?
- Beautifulness
 - Cancer causing
 - Looking unique
 - Looking presentable

30. Halima's mother suffers from hypertension. What advise should Halima give her mother to reduce and prevent the hypertension disorder?
- To take high amount of salt
 - To drink a lot of alcohol
 - Be doing physical exercise
 - Be eating foods rich in fat

31. Kocha had sh 700 to spend. He prepared a budget as shown below

Item	cost
1. 2 loaves of bread	120
2. Snacks	400
3. Maize flour	160
4. Match box	20
Total	700

Why do you think Kocha's budget was **not** good?

- He did not buy clothes
 - He had no savings
 - He spent all the amount
 - He should not have bought bread
32. Mutuku saw the care label below on his T-shirt.



What safety precaution should be taken when washing the T-shirt?

- Dry clean
 - Not to dry clean
 - To bleach
 - Not to bleach
33. Nana noticed that the edge of her school skirt had opened up thus causing hanging hems. What factors should she NOT consider when repairing the hanging hems?
- The size of the skirt
 - The colour of the thread used
 - The previously used stitches
 - The size of the hem to be mended

34. Akombe was cooking food using deep frying method. What safety measure should she observe when cooking?
- A. Use a shallow pan
 - B. Leave the pan unattended when cooking
 - C. Get too close to the cooking oil
 - D. Allow the oil to return to the correct cooking temperature before adding the next batch
35. Brian, a grade two boy is suffering from kwashiorkor. Which group of foods would be the best for him to eat?
- A. Ugali, rice, potatoes
 - B. Eggs, spinach, guavas
 - C. Milk, fish, meat
 - D. Oranges, pawpaws, watermelons

SECTION C:

AGRICULTURE (10mks)

36. Grade six learners at Kochogo primary school discovered that the soil in their school garden had been seriously eroded. How would they conserve the soil from erosion?
- A. Irrigating the land

- B. Fencing the land
- C. Replacing the lost soil using recovered soil from soil deposition
- D. Digging the terraces to prevent erosion

37. Njeri was taking a nature walk around their home and noticed the following:
- i) *Eroded soil deposited at the lower areas of the slope*

ii) *Roots of plants were exposed*

iii) *Stones below the top soil were exposed*

Which type of soil erosion was taking place?

- A. Sheet erosion
- B. Splash erosion
- C. Gulley erosion
- D. Rill erosion

38. Which one of the following is the **most** appropriate way of controlling gulley erosion?

By

- A. building porous dams
- B. planting cover crops
- C. planting trees
- D. mulching

39. The use of mulching for conservation of soil will work the same way as
- trashlines
 - gabions
 - terracing
 - cover cropping
40. During the Agriculture lesson, grade six learners suggested the ways of conserving water in soil. One of the ways they identified was use of sunken beds. Which of the following is **NOT** true about sunken beds?
- Sunken beds help soil to remain moist for a long time
 - Sunken beds are used to grow vegetables only
 - Sunken beds reduce soil erosion
 - Sunken beds are suitable in arid and semi-arid lands
41. On his way to school, Ben came across spoiled CDs and DVDs thrown beside the road. How would Ben reuse the CDs and DVDs in their school farm? To
- make play toys
 - try to play them on their DVD player
 - make light deflectors to scare away animals
 - hide them behind a bush near the farm

42. The following are crops that were identified by grade six learners during nature walk as creeping crops (**Passion fruit, watermelon, pumpkins, cucumber, calabash**). Among the identified crops, which one is ODD one out?
- Passion fruit
 - Calabash
 - Watermelon
 - Cucumber
43. Grade six learners constructed the structure drawn below as a way of caring for climbing fruit plants in their school garden.

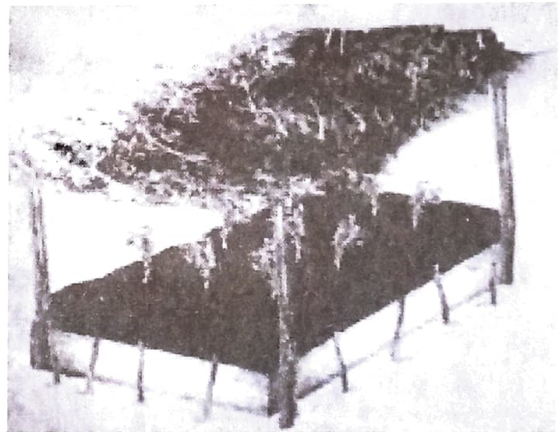

- Why is the structure important? It
- protects the plant from being damaged by animals
 - protects the plant from direct sunlight
 - enables the growth of the plant to be upright
 - reduces competition from weeds

44. Which of the following animals is NOT correctly matched with its use in the farm?

	Animals	Use
A.	Horse	For riding
B.	Fish	Source of food
C.	Pig	Produces milk
D.	Dog	Provides companionship

45. Grade six learners of Thithi Primary school collected the following materials for preparing organic waste pit. Which one was the **MOST** suitable?
- A. Wires
 - B. Metal objects
 - C. Coconut husks
 - D. Fruit peelings

SECTION D:

PHYSICAL & HEALTH EDUCATION (15mks)

46. Grade six learners wanted to perform a drop finish in track events. Which one is NOT a learning point for the skill?
- A. Focus ahead

- B. Approach the finish line at full speed
- C. Bend and push both arms backwards on reaching finishing line
- D. Bend forward on reaching finishing line

47. You are practising with your classmates the non-visual baton exchange method. What safety instruction should you heed to?

- A. Do not throw the baton to one another
- B. Be crowded in one place
- C. Do perform warm up activities
- D. Throw the baton to one another

48. Vivian was performing a scissor technique in High jump. How would be the flight after take off?

- A. Hold the leg away from the bar straight
- B. Once the lead leg is over the bar, kick the other foot to clear the bar
- C. Jump with your legs bent
- D. Do not swing your leg in the air to clear the bar

49. The following are stages of performance in standing javelin as done by Omari. Which one is **not**?
- A. Take off
 - B. Grip
 - C. Release
 - D. Carriage

50. Which one of the following events is correctly matched with its equipment used during the game?

	Equipment	Event
A.	Javelin	Shot put
B.	Short	Relay race
C.	Cross bar	High Jump
D.	Baton	Javelin

51. The following are skills learnt during rope skipping. Which one is **not**?
- A. Wounded-duck
 - B. Skier
 - C. Volley
 - D. Straddle

52. The following are equipment used in softball game. Which one is **not**?
- A. Leg guard
 - B. Bats
 - C. Helmet
 - D. Dust coat

53. Below is a picture of a skill performance in rounders.



The skill is called

- A. fielding
 - B. stamping
 - C. batting
 - D. catching
54. Two boys Okoth and Njau are practising push pass in soccer. Which part of the foot are they using to pass the ball? Middle part of the
- A. inside of the foot
 - B. outside of the foot
 - C. in step of the foot
 - D. back of the foot

55. A score in rugby is called
- A. run
 - B. goal
 - C. try
 - D. point
56. Koros wanted to perform a side vault. Which one is a learning point for him?
- A. Make short runs towards the vault
 - B. Place one hand on one end of the vault
 - C. Release the arm that is closer to the legs
 - D. Place both hands on one end of the obstacle
57. Which pair of activities below are performed to develop agility?
- A. Pivoting and shuttle running
 - B. Lateral running and crab walk
 - C. Crab walk and pivoting
 - D. Forward running and T-balance
58. A learner was playing in the field and got injured. He developed a closed wound. How should the learner **not** manage the wound? By
- A. resting the wounded part
 - B. compressing the wound
 - C. elevating the wounded part
 - D. opening the wounded part with a razor blade
59. During an outdoor activity, learners placed tracking signs along the paths. Why are the tracking signs important?
- A. Beautify roads and paths
 - B. They are difficult to understand
 - C. Lead to confusion
 - D. To find someone if they get lost
60. The following are factors to consider when choosing a suitable place for outdoor activities. Which one is **not**?
- A. Security
 - B. Type of clothing to wear
 - C. Services and amenities
 - D. Mode of transport



JOPO LA MTHANI WA COMPASS
UTABIRI WA KPSEA

GREDI YA SITA - 2022

KISWAHILI
SEHEMU YA KWANZA:
LUGHA

Muda: Saa 1 Dakika 40

MAAGIZO KWA MTAHINIWA (Soma kwa makini maagizo yafuatayo)

1. Umepewa kijitabu hiki cha maswali na karatasi ya kujibu. Kijitabu hiki kina maswali 40.
2. Ukisha chagua jibu lioneshe katika **KARATASI YA MAJIBU** na wala sio katika kijitabu cha maswali.
JINSI YA KUTUMIA KARATASI YA MAJIBU
3. Tumia penseli ya kawaida.
4. Hakikisha ya kwamba yafuatayo yameandikwa katika karatasi ya majibu: -
NAMBARI YAKO YA MTHANI
JINA LAKO
JINA LA SHULE YAKO
5. Kwa kuchora kistari katika visanduku vyenye nambari zinazokuhusu, onyesha namba yako kamili ya mthani (yaani nambari ya shule. Na zile namba tatu za mtaahiniwa) katika sehemu iliyotengwa mwanzo wa karatasi ya majibu.
6. Usitie alama zozote nje ya visanduku.
7. Iweke safi karatasi yako ya majibu
8. Kwa kila swali 1-40 umepewa majibu manne. Majibu hayo yameonyeshwa kwa herufi A, B, C, D. Ni jibu **MOJA** tu kati ya hayo manne ambayo ni sahihi. Chagua jibu hilo
9. Kwenye karatasi ya majibu, jibu sahihi lioneshwe kwa kuchora kistari katika kisanduku chenye herufi uliyochagua kuwa ndilo jibu.

Mfano:

Katika kijitabu cha maswali:

Kutoka swali 16 - 30 chagua jibu sahihi.

17. Kamilisha methali ifuatayo;
Ukali wa moto ni _____
A. kukuchoma
B. kuunguza
C. kuuchochea
D. kuteketeza
Jibu sahihi ni C.
Katika karatasi ya majibu

16. [A] [B] [C] [D] 17. [A] [B] [C] [D] 18. [A] [B] [C] [D] 19. [A] [B] [C] [D]

Katika visanduku vinavyoonyesha majibu ya swali namba 17, kisanduku chenye herufi C ndicho kilichochorwa kistari.

10. Chora kistari chako vizuri. Kistari chako cheusi na kisijitokeze nje ya kisanduku.
11. Kwa kila swali, chora kistari katika kisanduku kimoja tu kati ya visanduku vinne ulivyopewa.

Kijitabu hiki kina kurasa 8 zilizopigwa chapa.

© compasspress, 2022

Chagana picha ifuatayo kisha ujibu maswali 1-5



1. Watoto wale wanafaa kufanya nini punde wanapomwona yule mzee aliyebeba mzigo?
 - A. Wasite kidogo
 - B. Waendeleo kucheza
 - C. Waelekeze mpira kwa mzee
 - D. Kumwalika mzee mchezoni
2. Mzee anapofika karibu na watoto wale ataomba nafasi kupita kwa kusema
 - A. samahani
 - B. nipe nafasi
 - C. kunradhi
 - D. simile
3. Watoto watamwambia mzee kwa kusema nini iwapo ulikuwa wakati wa mashariki?
 - A. Sabalkheri
 - B. Shikamoo
 - C. Hujambo mzee
 - D. Salam aleikum
4. Mzee atajibu vipi baada ya kusalimiwa?
 - A. Sabalkheri
 - B. Sabalkhanuri
 - C. Akheri
 - D. Sina neno
5. Baada ya kuamkiana watoto watamuaga mzee kwa heshima kwa kusema, **“buriani.”** Mzee atajibu kwa kusema “_____”
 - A. buriani
 - B. buriani dawa
 - C. binuru
 - D. ya kuonana

Soma kifungu kifuatacho kwa makini kisha ujibu maswali 6-9

Ng'ombe na simba walikuwa marafiki wa kufa kuzikana. Kati ya hawa wawili, hakuna mmoja ambaye hakufaidika kutoka kwa mwenzake. Simba alikuwa na mashamba makubwa ambayo yalimpa ng'ombe lishe ya kila siku. Mfalme huyu wa wanyama alikuwa akipenda sana kunywa chai ya maziwa. Maziwa haya aliyapata kwa ng'ombe. Wote waliishi pamoja kwa umoja na utangamano.

Uhasama wa wanyama hawa ulianza zama za kale kabla ulimwengu haujapata maarifa tuliyo nayo hivi leo. Uhasama huwa hunikumbusha kuwa hata marafiki wakubwa kabisa wanaweza kukosana. Viumbe hawa walikosana na kamwe hawapikiki katika chungu kimoja mpaka leo. Kama si wana wao, wanyama hawa wawili wangekuwa marafiki hadi mwisho wa dunia.

Siku moja ndama na mwanasimba walikuwa wakicheza pamoja kwa furaha na bashasha. Wazazi walikwenda usasini. Katika zile hekaheka za kucheza pamoja ukazuka mkasa bin mkosi uliozaa balaa na belua. Mwana ng'ombe alimdunga mwanasimba kwa pembe. Ilikuwa ni ajali. Sote tunafahamu kuwa ajali haina kinga wala kafara.

Machweo yalipowadia, wazazi walirejea nyumbani. Walimpata mwanasimba akipukutikwa na machozi pukupuku. Ndama naye alikuwa akidundwa na mtima du du du. Punde si punde, mama simba alipashwa habari. Wacha achemke nyongo. Taharuki na mtafaruku vilishamiri. Ng'ombe na mwanawe pale hapakuwaweka tena. Ngo'ombe na ndama wake walitundika miguu mabegani na kutokomea. Walienda kutafuta hifadhi katika makazi ya mwanadamu. Ama kwa hakika mgeni njoo mwenyeji apone. Tangu wakati huo, wanadamu na watoto wake wanaburudikia maziwa ya ng'ombe.

6. Kulingana na aya ya kwanza, unafikiri urafiki ule ulichochewa na nini?
- A. Walikuwa marafiki wa kufa kuzikana
 - B. Simba alikuwa na mashamba makubwa
 - C. Wote waliishi pamoja kwa utangamano
 - D. Kila mmoja alifaidika kutoka kwa mwenzake
7. Tunajifunza nini kutokana na aya ya pili?
- A. Urafiki wa dhati unaweza kubadilika na kuwa uadui
 - B. Marafiki hawawezi kukosana kamwe
 - C. Marafiki wengi hawapikiki katika chungu kimoja
 - D. Wana wa watu huwakosanisha watu kila mara
8. Mama simba na mama ng'ombe walikuwa wakifanya kazi gani?
- A. Wakulima
 - B. Wazazi
 - C. Kuwida
 - D. Vibarua
9. Mwanadamu anafaidi nini kutokana na ng'ombe?
- A. Maficho
 - B. Maziwa
 - C. Kuishi naye
 - D. Kumwoko

Soma mazungumzo yafuatayo kisha ujibu maswali 10-13

Mwalimu: Fatuma, hebu nitajie viungo vya ndani vya mwili wa binadamu.

Fatuma: Mwalimu, naomba unipe muda wa kukumbuka. Je, mwalimu, viungo vya ndani na viungo vya nje vina tofauti gani?

Mwalimu: Fatuma, mtu hawezi kulijibu swali kwa swali jingine. Wewe jibu swali uliloulizwa ili tufahamu iwapo unaelewa au la.

Fatuma: Haya, samahani mwalimu. Sasa nimekumbuka. Viungo hivyo ni macho, pua, uso, kichwa, mikono naaa...

Mwalimu: Ala! Nataka uelewe kuwa sikuulizi kuhusu viungo vya nje vya mwili ila vya ndani. Haya, hebu nikudokezee. Viungo vya ndani huwa havionekani unapomwona mtu.

Fatuma: (*Huku akitabasamu*) Aha! Mwalimu, sasa nimelielewa swali. Nilivyovitaja vilikuwa viungo vya nje vya mwili. Viungo hivi ni kama vile: kibofu, ini, vigo, mapafu, utumbo na...

Mwalimu: Hongera Fatuma. Umegonga ndipo. Sasa najua waweza kujua umuhimu wa viungo hivi. Je, viungo hivi hufanya kazi gani mwilini?

10. Je, ni jambo gani la adabu limekosekana katika mazungumzo ya mwalimu na mwanafunzi pale mwanzoni?
- A. Maagano
B. Majina ya wazungumzaji
C. Wazungumzaji hawajajuana
D. Maamkizi
11. Mazungumzo kama haya yanapoendelea kwa muda mrefu huitwaje?
- A. Tamthilia
B. Hadithi
C. Kitabu
D. Ngano
12. Unafikiri ni kwa nini Fatuma alikosa kulijibu swali aliloulizwa na mwalimu? Kwa sababu
- A. hajui viungo vya ndani vya mwili
B. hajui viungo vya nje vya mwili
C. hakuwa amelielewa swali barabara
D. mwalimu hakumpa muda wa kufikiria
13. Kwa mujibu wa swali la mwisho la mwalimu, **kibofu** hufanya kazi gani mwilini?
- A. Kutakaza damu mwilini
B. Kuhifadhi mkojo kwa muda
C. Kuondoa uchafu mwilini
D. Kushikilia nyama na misuli

Soma shairi lifuatalo kisha ujibu maswali 14 - 17.

Tangu enzi za zamani, na magonjwa twashikana
Hivi leo yamukini, madawa tuweze pona
Maradhi siyo kiini, bali ghoshi kutiana
Dawa zinazolevya, tunasema ni haramu

Babu walikunywa pombe, wakinena ya muhimu
Vijana wanywa pombe, meifanya kuwa sumu
Wajifanya kuwa wembe, kulewa ndilo jukumu
Kulewa pombe jamani, kunaleta masaibu

Vijana wengi shuleni, ni kama wana mahoka
Hawataki asilani, ya walimu kusikika
Wazidi ufidhulini, matawi wawe kushtuka
Wamekuwa majabari, wanaongozwa na bangi

Miraa mwaitafuna, mwaona kuwa ridhaa
Kwa magari mwafatana, hamwoni ni balaa
Kwenye manza kushindana, eti gani inafaa
Dawa za kulevya, twasisitiza muache

14. Shairi hili ni la bahari gani?
A. Takhmisa B. Tarbia C. Tathlitha D. Utenzi
15. Ni kwa nini wanasayansi walibuni aina za dawa?
A. Kukabiliana na maradhi B. Kutiana ghoshi
C. Kuzidua kiburi D. Kuzua beluwa
16. Wazee wa zama walikunywa pombe
A. ili wawe na kiburi B. ili kujifanya kuwa wembe
C. ili kuzungumza ya busara D. ili kuleta masaibu
17. Habari inayotokeza kwenye shairi si ya
A. kuridhika na dawa za kulevya B. shutuma juu ya mihadarati
C. tuhuma dhidi ya mihadarati D. madhara ya dawa za kulevya

Soma habari ifuatayo kisha ujibu maswali 18-20

Insha ni mtungo unaoandikwa kuhusiana na vipengele vitatu. Yaani kuhusu ukweli au uhalisia, uwezekano au ubunifu wa jambo fulani, tukio au kisa kwa kutumia lugha nathari ili kuwasilisha ujumbe fulani kwa msomaji au hadhira.

Katika kujifunza Kiswahili, Insha ndio upeo wa ujifunzaji wa lugha yenyewe. Kuandika ndiyo stadi ya mwisho ambapo matunda ya ukomavu hudhihirika. Kwa kawaida, kuna stadi nne muhimu za lugha hii ambazo ni lazima zishughulikiwe kwa utaratibu unaofaa.

Hii ni kwa sababu hata mtoto anapozaliwa ni lazima aanzie hatua zile nyepesi kwanza. Yeye hufanya hivyo hatua kwa hatua kabla ya zile zenye changamoto. Mathalani, azaliwapo hujua kunyonya moja kwa moja, ajue kuketi kwa kugemea kitu, kuketi bila msaada, kutambaa, kusimama kwa kushikilia vitu, kusimama tisti, aanze kutembea thabiti na kadhalika. Nako kujifunza lugha kuna hatua nne yaani: kusikiliza, kuongea, kusoma na kuandika.

18. Insha ni sanaa ya uandishi inayohusu
A. uandishi B. kusikiliza C. kusoma D. kuzungumza
19. Ufundi wa insha umefananishwa kama makuzi ya mtoto kwa vile
A. mtoto hulelewa akiandika insha B. hufuata hatua baada ya nyingine
C. matunda ya ukomavu hudhihirika D. insha ndiyo upeo wa ujifunzaji wa lugha
20. Hatua ya mwisho ya makuzi ya mtoto ni gani kulingana na taarifa uliyoisoma?
A. Kunyonya moja kwa moja B. Kusimama tisti
C. Kuketi bila msaada D. Kwenda masia thabiti

Kutoka swali 21-25, chagua jibu bora zaidi kujazia mapengo.

Wakati mabeberu wazungu ___ 21 ___ hapa kwetu Kenya, mipango ya elimu ya wasichana ___ 22 ___ sana. ___ 23 ___ watu wengi walipenda ___ 24 ___ watoto wao wa kike. Lakini ilikuwa ___ 25 ___ kuwapatia elimu kamili.

21. A. walikoingia B. walipoingia C. walipoondoka D. waliondoka
22. A. ilikuwa hafifu B. walikuwa hafifu C. haikuwa hafifu D. kulikuwa hafifu
23. A. Ikiwa B. Ingawa C. Kwani D. Ajili
24. A. kusoma B. kuwasomea C. kuwasomesha D. kujisomea
25. A. ngumu B. gumu C. vigumu D. mgumu

Kutoka swali la 26 mpaka 40, chagua jibu lililo sahihi

26. Nomino ipi haijaambatanishwa na ngeli sahihi?
A. Mbuzi- I-ZI B. Moyo- U-ZI C. Mvua- I-I D. Mfugo- U-I
27. Ni sentensi gani iliyo sahihi?
A. Wanafunzi wanaenda shule kwa miguu.
B. Wanafunzi wameenda safarini na basi.
C. Mwalimu ameenda kwa ofisi.
D. Mtoto anakula kwa kijiko.
28. Chombo kinachotumiwa kukunia nazi huitwaje?
A. Mbuzi B. Karo C. Chano D. Buli
29. Kanusha sentensi hii: **Enda mtoni leo.**
A. Hataenda mtoni leo. B. Hajaenda mtoni leo.
C. Usiende mtoni leo. D. Siende mtoni leo.
30. Suruali fupi inayovaliwa na wavulana huitwa **kaptura** au _____
A. bombo B. longi C. kizibao D. suruali
31. Chagua sentensi yenye **kielezi**.
A. Yule alilalamika kuwa ameonewa.
B. Wavulana watatu walionekana nadhifu.
C. Hakunisaidia ingawa alijua shida yangu.
D. Mwanamwali alitembea jukwaani kwa maringo.
32. Umbo hili huitwaje?

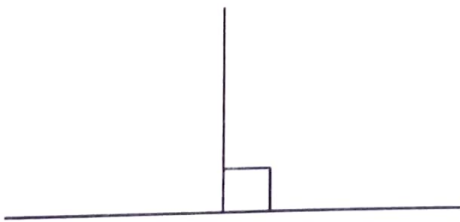

- A. Mstatili B. Mstari sulubu C. Msalaba D. Nusu kipenyo
33. Akisami $\frac{9}{10}$ husomwaje?
A. Ushuri tisa B. Thumni kumi C. Tusui kumi D. Subui tisa

34. Tumia kiambishi -**amba**- kwa usahihi. Mvua _____ **hunyesha vizuri huleta manufaa.**
A. ambao B. ambayo C. ambalo D. ambacho
35. **Mwang'ombe alienda shuleni shingo upande.** Hiyo ina maana kuwa
A. Mwang'ombe alikataa kuenda shuleni.
B. Mwang'ombe alienda shuleni kwa hiari.
C. Mwang'ombe hakuenda shuleni kwa hiari.
D. Mwang'ombe alienda shuleni akiinamisha kichwa.
36. **"Sijafika mapema wala sijampata."** Sentensi hii i katika wakati gani?
A. Uliopo B. Timilifu C. Tegemezi D. Uliopita
37. Unganisha vifungu vifuatavyo ili upate sentensi yenye mtiririko aula.
i) ana shamba kubwa *ii) pale Mombasa*
iii) mwanamke *iv) huyu ni mjane lakini*
A. Mwanamke huyu ni mjane lakini ana shamba kubwa pale Mombasa.
B. Mjane huyu mwanamke lakini ana shamba kubwa pale Mombasa.
C. Pale Mombasa huyu ni Mjane lakini ana shamba kubwa
D. Mwanamke huyu ni mjane pale Mombasa lakini ana shamba kubwa.
38. Andika katika kauli halisi. **"Abiria waliambiwa kuwa magari yangukuja."**
A. "Magari yalikuja," abiria waliambiwa.
B. "Magari hayaji," abiria waliambiwa.
C. "Magari yatakuja," abiria waliambiwa.
D. "Magari hayatakuja," abiria waliambiwa.
39. Mkono wa ndovu huitwa _____
A. kipusa B. gobori C. mwiro D. pembe
40. Ni sentensi ipi iliyo na **viambishi radidi**?
A. Mbwa niliyemtaka ndiye huyu huyu. B. Mbwa niliyemtaka ndiye yuyu huyu.
C. Mbwa niliyemkata si yuyu huyu. D. Mbwa niliyemtaka siye yuyu huyu.

THE COMPASS EXAMINATION BOARD
KPSEA PREDICTION



GRADE 6 - 2022

MATHEMATICS

Time: 2hrs

INSTRUCTIONS TO CANDIDATES (Read these instructions carefully)

1. You have been given this question booklet and a separate answer sheet. The question booklet contains **40** questions.
2. Do any necessary rough work in this booklet.
3. When you have chosen your answer mark it on the **ANSWER SHEET**, not in the question paper.

HOW TO USE THE ANSWER SHEET.

4. Use an ordinary pencil only.
5. Make sure that you have written on the answer sheet:-
YOUR ASSESSMENT NUMBER
YOUR NAME
NAME OF YOUR SCHOOL
NAME OF SUBJECT
6. Do not make any marks outside the boxes.
7. Keep your answer sheet as clean as possible and **DO NOT FOLD IT**.
8. For each of the questions 1-40 four answers are given. The answers are lettered A, B, C, D. In each case only **ONE** of the four answers is correct. Choose the correct answer from the choices.
9. On the answer sheet show the correct answer by drawing a **dark line** inside the box in which the letter you have chosen is written.

**Example
In the Question Booklet**

21. Write 39 in Roman numbers.

- A. XXXIX
- B. XLIX
- C. XXIX
- D. LXIX

The correct answer is **A**

On the answer sheet:

21. [A] [B] [C] [D] 22. [A] [B] [C] [D] 23. [A] [B] [C] [D] 24. [A] [B] [C] [D]

In the set of boxes number **21**, the box with letter **A** printed in it is marked.

10. Your **dark line MUST BE** within the box.
11. For each question **ONLY ONE** box is to be marked in each set of four boxes.

This question paper consists of 8 printed pages.

© compasspress, 2022

1. Bogita planted seventy nine thousand, four hundred and three tree seedlings in a certain rainy season. What is the number of the seedlings in symbols?
- A. 7904003
B. 709403
C. 794003
D. 79403
2. There were 37928 grade six learners in Amani County. What is the total value of digit 7 in the number?
- A. Tens
B. Seventy
C. Seven thousand
D. Thousands
3. A group of farmers delivered 83714 bags of rice in April to a factory. In May the farmers delivered 1983 less bags of rice to the factory. How many bags did the farmers deliver in May?
- A. 85697
B. 82831
C. 82731
D. 81731
4. In the year 2020, a school received 2103 books. By the end of the year 249 books got spoiled and were replaced by 286 new books. How many books were in good condition after the replacement?
- A. 2639
B. 2140
C. 1854
D. 1568
5. A fruit seller had some fruits. She wanted to put them in equal piles of 12 and 15. What was the lowest number of fruits that she could divide into equal piles of 12 and 15 without a remainder?
- A. 180
B. 60
C. 27
D. 3
6. Work out: $3045 \div 15$
- A. 2003
B. 203
C. 230
D. 23
7. During a Mathematics activity four learners had the following number of cards
- | | | | |
|-------|-------|-------|-------|
| John | Mary | Rita | Peter |
| 36224 | 58809 | 60795 | 78910 |
- They rounded off the numbers to the nearest thousands and got their answers as shown below.
- | | | | |
|-------|-------|-------|-------|
| John | Mary | Rita | Peter |
| 36200 | 58000 | 61000 | 78900 |
- Who rounded off correctly?
- A. Rita
B. John
C. Mary
D. Peter

8. Ahmed imported 13018 mobile phones in November. In December he imported 7391 more mobile phones. How many mobile phones did he import in the two months?
- A. 33427
B. 33417
C. 20409
D. 5627
9. Mwalala has a square seedbed. Each side of the seedbed is 36 metres. What is the area of the seedbed?
- A. 6m^2
B. 14m^2
C. 1156m^2
D. 1296m^2
10. Work out the value of $81 \div 9 \times 3 + 10$.
- A. 37
B. 31
C. 27
D. 18
11. Beth bought $\frac{3}{4}$ kg of meat. She cooked a $\frac{1}{2}$ kg piece of the meat for her family. She gave the remaining piece of meat to her neighbour. What fraction of the meat did she give the neighbour?
- A. $\frac{1}{4}$
B. $\frac{1}{2}$
C. $\frac{3}{8}$
D. $\frac{5}{4}$
12. What is the next number in the pattern
1, 9, 25, 49, 81, _____?
- A. 83
B. 91
C. 121
D. 169
13. A bookseller bought 184 cartons of books. Each carton contained 25 books. He sold 3712 books. How many books remained?
- A. 4600
B. 4575
C. 888
D. 998
14. Chebet had $58\frac{1}{2}$ m of wire mesh. She used $36\frac{4}{5}$ m of the wire to fence round her vegetable garden. What length of wire mesh remained?
- A. $22\frac{3}{10}$
B. $21\frac{7}{10}$
C. $18\frac{7}{10}$
D. $\frac{7}{10}$

15. The height of a building is 120.27m. The ground floor is 5.99m high. What is the height of the remaining part of the building?
- A. 126.26
B. 124.28
C. 114.38
D. 114.28

16. A grade five learner had four number cards as follows



She arranged the number cards from the largest to the smallest. Which one of the following is the correct order?

- A. 0.57, 1.057, 1.57, 1.6
B. 1.6, 1.57, 1.057, 0.57
C. 0.57, 1.6, 1.57, 1.057
D. 1.057, 1.57, 0.57, 1.6
17. Auma was asked by her class teacher to fill in the table below during a Mathematics lesson.

Number	1	2	9	.	0	8	4
Place value							

What is the place value of digit 8 in the number?

- A. Tens
B. Tenths
C. Hundredths
D. Thousandths

18. During an activity in a Mathematics lesson, learners had the following 3-D objects which are found in the environment. The teacher asked them to name the objects.

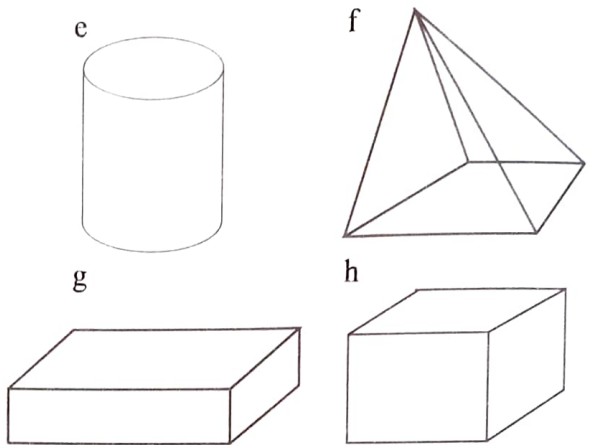

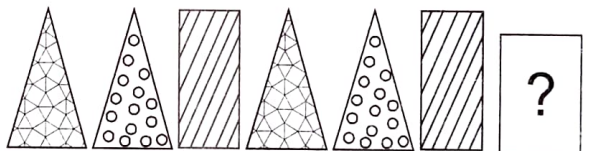

What are the correct names?

- A. (e) cylinder (f) cuboid (g) pyramid (h) cube
B. (e) cylinder (f) pyramid (g) cuboid (h) cube
C. (e) pyramid (f) cylinder (g) cube (h) cuboid
D. (e) cube (f) cuboid (g) pyramid (h) cylinder
19. Moraa used shapes to make a pattern as shown.

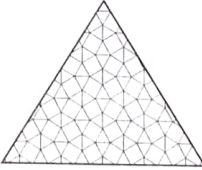

Which one of the following did she put in the box to continue with the pattern?

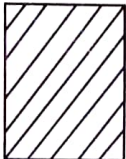
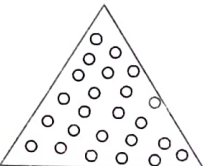
- A.  B. 
C.  D. 

20. John saw the following structure at a building construction site. He then identified the angles marked with Roman numerals.

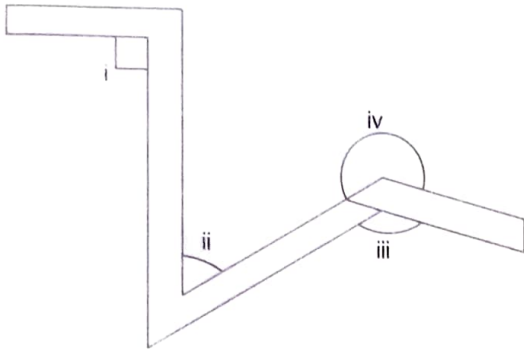

Which of the following shows the correct names of the angles?

- A. (i) Acute (ii) Obtuse (iii) Right angle (iv) Reflex
 B. (i) Obtuse, (ii) Reflex (iii) Acute (iv) Right angle
 C. (i) Right angle (ii) Acute (iii) Obtuse (iv) Reflex
 D. (i) Right angle (ii) Reflex (iii) Obtuse (iv) Acute
21. Wafula measured the angle drawn below using a protractor.

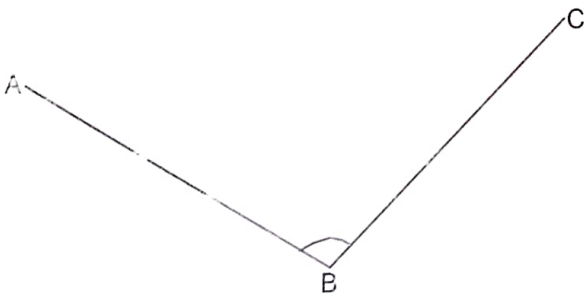

What is the correct size of the angle ABC?

- A. 115°
 B. 105°
 C. 85°
 D. 75°

22. The table below represents the number of patients who were treated of malaria in a certain hospital in five days of the week.

Day	Mon	Tue	Wed	Thur	Fri
No. of people	8	4	12	10	12

Mutwiri piled bottle tops to represent the number of patients treated in each day. How many more bottle tops did he pile to represent number of patients on Thursday than on Tuesday?

- A. 14
 B. 10
 C. 6
 D. 4

23. Four learners were discussing the services offered by the banks. Who among them gave incorrect answer?

- A. **Peter:** Giving loan to people
 B. **Tom:** Withdrawing money
 C. **Alice:** Keeping valuable items
 D. **Ann:** Paying taxes for people

24. The government uses taxes to provide the following services **except**

- A. to construct roads
 B. to build hospitals
 C. to build worship places
 D. to supply electricity

25. The table below shows price list in a shop.

Item	Price
Bread	sh 55
Packet of milk	sh 60
2kg packet of sugar	sh 215
1kg of cooking oil	sh 418
Bottle of water	sh 50

Zanida bought the following items:-

A packet of sugar, 2 packets of milk, a loaf of bread and a bottle of water. How much balance did she get from sh 1000 note?

- A. Sh 798
- B. Sh 440
- C. Sh 560
- D. Sh 405

26. A farmer harvested 428kg of beans, 854kg of maize and 465kg of rice. What is the total mass that she harvested?

- A. 1747
- B. 1732
- C. 1708
- D. 1648

27. In a walking race, Odero took 23 minutes 51 seconds to finish while Kioko took 25 minutes 39 seconds. By how many minutes and seconds was Kioko ahead of Odero in the race?

- A. 1 minute 48 seconds
- B. 1 minute 46 seconds
- C. 48 seconds
- D. 1 minute 28 seconds

28. A doctor bought 12 litres of a certain medicine to treat some patients. What was the amount of medicine in millilitres?

- A. 120000
- B. 12000
- C. 1200
- D. 120

29. Mirema bought 120kg of meat during a community function. He repacked the meat into $\frac{1}{4}$ kg portions. How many portions did he get?

- A. 30
- B. 60
- C. 360
- D. 480

30. A nurse takes 3 minutes 49 seconds to vaccinate one baby. How long would she take to vaccinate 4 babies?
- A. 44 minutes 15 seconds
 B. 44 minutes 12 seconds
 C. 15 minutes 16 seconds
 D. 42 minutes 15 seconds

31. The length of a box is 9cm, the width is 7cm and the height is 14cm. What is the volume of the box?
- A. 1082cm^3
 B. 882cm^3
 C. 782cm^3
 D. 30cm^3

32. During a rainy season, Musa harvested 180 litres 40millilitres of water in seven equal buckets. How much water was in each bucket?
- A. 205L 720 ML
 B. 25L 720ML
 C. 25L 72ML
 D. 15L 720ML

33. Judy made a box shown below. She filled it with soil to plant seeds.

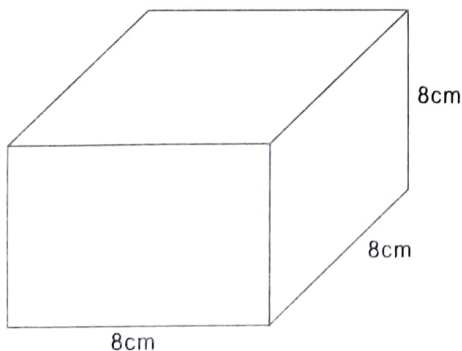

What volume of soil filled the box?

- A. 24cm^3
 B. 64cm^3
 C. 512cm^3
 D. 548cm^3
34. The distance between Khai's home and health centre is 2km 10m. What is the distance in metres only?
- A. 2100m
 B. 2010m
 C. 20100m
 D. 200010
35. The table below shows distance between some areas within Nairobi. The distances were measured from the city centre.

Place	Distance
Westlands	3km 760m
Kasarani	16km 500m
Imara Daima	11km 400

Amina travelled from Imara Daima to city centre then to Westlands. What distance did she cover?

- A. 11km 400m
 B. 31km 660m
 C. 15km 160m
 D. 3km 760m

36. Work out: $t + 7 = 21$
- A. 3
B. 28
C. 14
D. 147
37. Mwau had 3 baskets with equal number of fruits. The total number of fruits in the baskets was 150. How many fruits are in each basket?
- A. 45
B. 120
C. 50
D. 450
38. Silas is a leader of youth groups. He bought x motorcycles. He shared the motorcycles equally among 7 groups. Each group received 10 motorcycles. Form an equation to represent this information.
- A. $x \div 7 = 10$
B. $7x = 10$
C. $10 \div x = 7$
D. $7 \div x = 10$

39. Mwenje made square tiles whose sides were 28cm by 28cm. What is the total area of 10 such tiles?
- A. 56cm^2
B. 560cm^2
C. 784cm^2
D. 7840cm^2
40. Jacob had a rectangular cardboard. He removed a square piece from it to make a pattern.

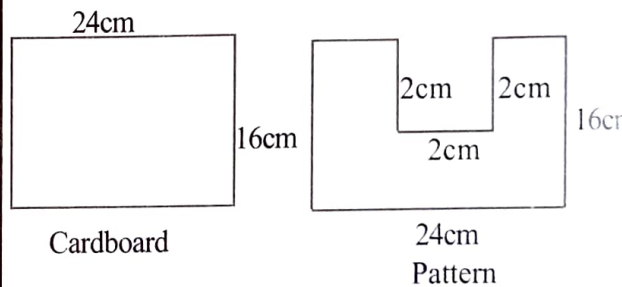

Which one of the following statements is true?

- A. Their perimeters are equal
B. Perimeter of the cardboard is less than the perimeter of the pattern
C. The perimeter of the pattern is less than that of the cardboard.
D. The perimeter of the cardboard is greater than that of the pattern